

CO Gas Module 0~10ppm

# TB600B-CO-10

## Technical Specification

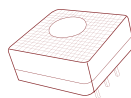

**Printing Solid Polymer Electrochemical Gas Technology**

Small size | Long life | Low cost | High accuracy | Fast response | Lower power consumption

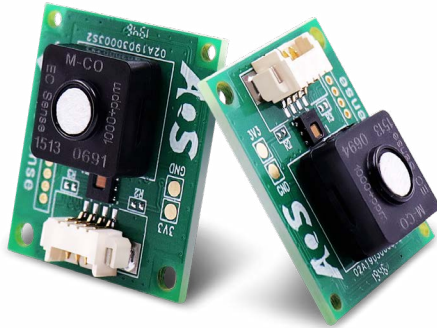

- ☞ PPB level high-precision environmental monitoring application;
- ☞ Strong anti-interference ability;
- ☞ Long life, stable detection and higher reliability;
- ☞ New micro circuit design, strong anti-electromagnetic interference ability;
- ☞ Quick response, fast return to zero, plug and play;
- ☞ Independent temperature and humidity digital sensors, combined with intelligent algorithms, have stronger environmental adaptability, more accurate and long-term stability;
- ☞ Small size and low power consumption.



## Product Overview

The TB600B series CO carbon monoxide module has many high-precision detection technologies from Sensor and circuit team together. The sensor uses the world's smallest solid polymer sensor from EC Sense, Germany. It can replace our nose to sniff out the gas concentration accurately, and realize accurate gas detection. The module uses UART digital output, make easy for customer use, eliminating the need for customers to understand the sensor application and the tedious work of calibration.

## Application

- ☞ Indoor household carbon monoxide pollution monitoring
- ☞ Monitoring of indoor carbon monoxide pollution in commercial premises (office, rooms, shopping malls, airports, train stations, gyms, hotels)
- ☞ Gas monitoring for small drones
- ☞ Indoor temperature and humidity monitor
- ☞ Medical respiratory disease detection equipment



## Principle

Solid polymer electrochemical technology is a revolutionary innovation in the field of electrochemical detection. This technology is based on the principle of electrochemical catalytic reaction, detecting the output signals of the electrochemical reactions of different gases, and accurately measuring the gas concentration through the signal.

The sensor is composed of three electrodes in contact with the electrolyte. A typical electrode consists of a large surface area of precious metal and other materials. The electrode, electrolyte and the surrounding air are in contact, and the gas diffuses through the back of the porous membrane into the working electrode of the sensor. At this electrode, the gas is oxidized or reduced, and this electrochemical reaction causes a current to flow through the external circuit.

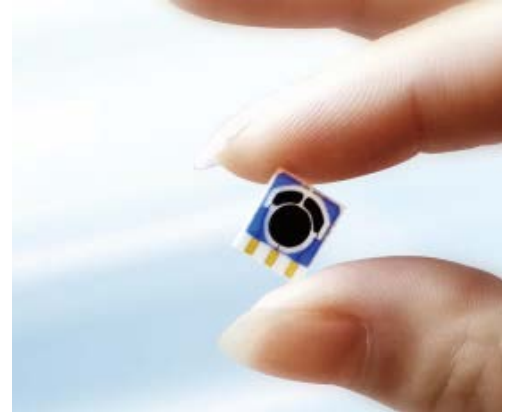

## Features

- ☞ High accuracy and long life
- ☞ Fast response speed, fast return to zero, plug and play
- ☞ Good anti-toxicity
- ☞ Easy to use, UART digital signal output
- ☞ German sensors are durable and reliable
- ☞ Excellent accuracy, repeatability, linearity and consistency
- ☞ Zero drift
- ☞ Strong anti-electromagnetic interference ability
- ☞ With fixed mounting holes for easy installation
- ☞ Sleep design for low power IOT applications
- ☞ Independent temperature and humidity digital sensor output
- ☞ RoHS environmental design

## Standards

GB / T18883-2002 "Indoor Air Quality Standard"

GB3095-1996 "Ambient Air Quality Standard"

European Directive 2002/231 / CE

Taiwan "Indoor Air Quality" Standard

EMC related test standards, European standard EN55022, American standard FCC

### Cross Sensitivity (based on CO carbon monoxide gas after calibration)

Gas	Molecules formula	Concentration (ppm)	Response (ppm)
Carbon monoxide	CO	10	10
Nitrogen dioxide	NO <sub>2</sub>	50	0
Formaldehyde	HCHO	1	0
Hydrogen	H <sub>2</sub>	1000	1.6
Ethanol	C <sub>2</sub> H <sub>6</sub> O	104.2	0
Ethylene oxide	C <sub>2</sub> H <sub>4</sub> O	14.4	0
Benzene	C <sub>6</sub> H <sub>6</sub>	986.5	0
Ammonia	NH <sub>3</sub>	50	0
Ozone	O <sub>3</sub>	50	0
Methane	CH <sub>4</sub>	5000	0
Acetylene	C <sub>2</sub> H <sub>2</sub>	80.3	0
Methane	CH <sub>4</sub>	3.04%vol	0
Isobutene	C <sub>4</sub> H <sub>8</sub>	300	0
Trichloroethylene	CH <sub>2</sub> Cl <sub>2</sub>	30	0

Note: Dimethylamine, hydrogen cyanide, methanol, toluene, xylene, liquid gasoline, and trichloroethylene have no interference below 10ppm. Other concentrations need to be tested separately.

### Linearity

Temperature environment: 26°C ; Humidity environment: 55%; Air chamber space: 0.03m<sup>3</sup>; Ventilation flow of air distribution system: 4000sccm

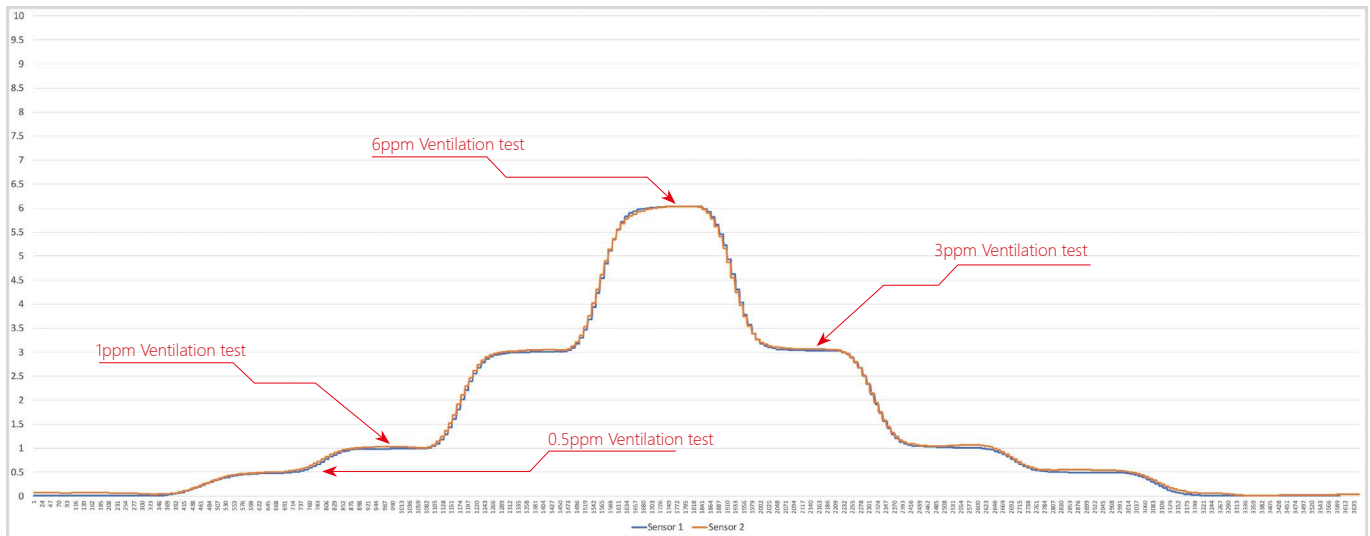

Test result: 0 ~ 10ppm linear error <± 5%;

### Zero Drift Testing (More than 12 hours)

Temperature environment: 26°C ; Humidity environment: 50%; Air chamber space: 0.03m<sup>3</sup>; Ventilation flow of air distribution system: 4000sccm

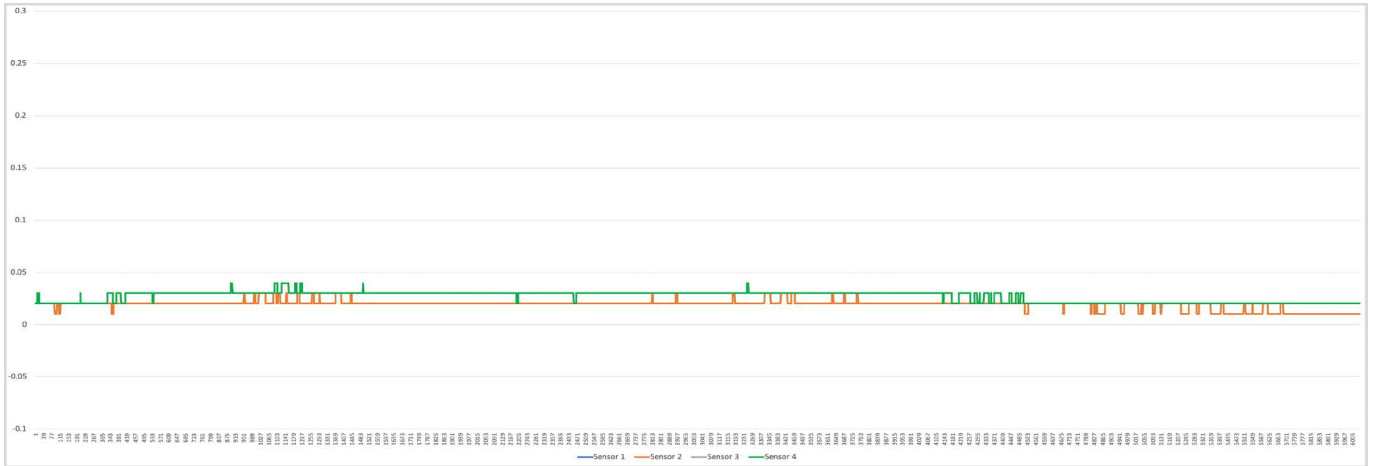

The test results show that the 12-hour relative clean air test has a zero drift range of <0.05ppm(0-0.3ppm is the normal zero fluctuation range);

### 5ppm Sensitivity Drift Testing

Temperature environment: 26°C ; Humidity environment: 55%; Air chamber space: 0.03m<sup>3</sup>; Ventilation flow of air distribution system: 4000sccm

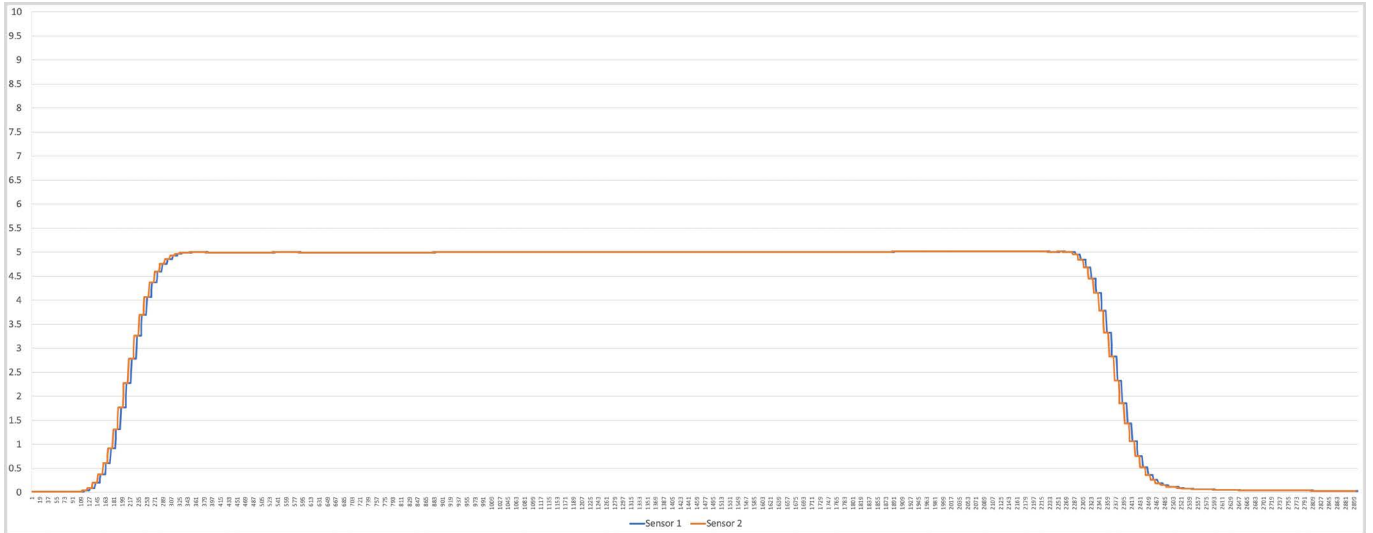

Test result: 2 hours ventilation, range drift <0.1ppm;

## Repeatability

Temperature environment: 26°C ; Humidity environment: 50%; Air chamber space: 0.03m<sup>3</sup>; Ventilation flow of air distribution system: 4000scm

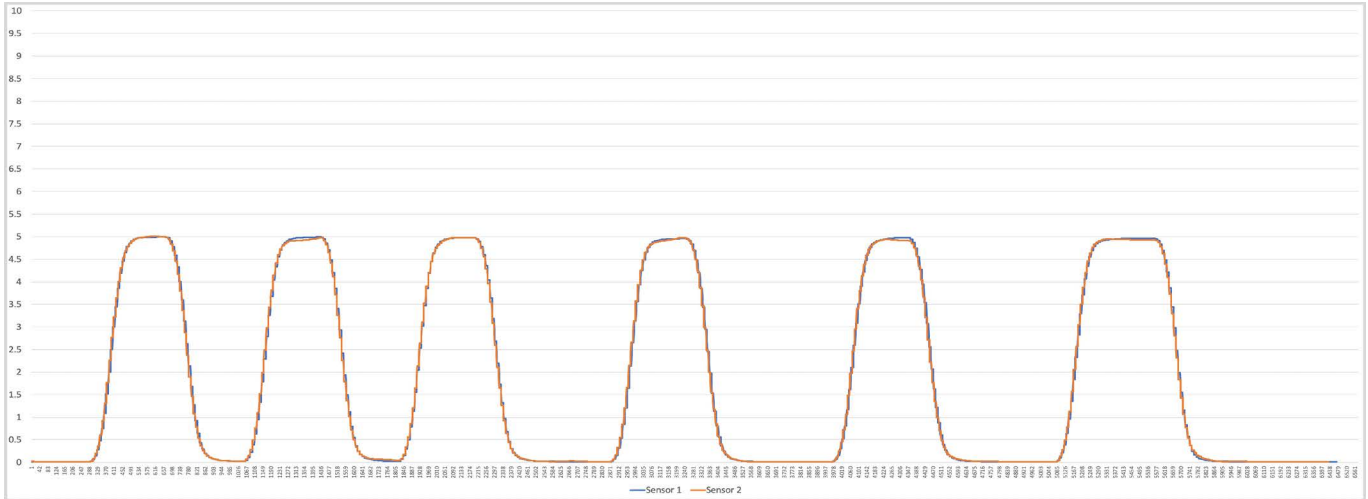

The test results show that the repeatability error range is <0.1ppm (10ppm ± 1% of full scale is the normal range);

## Structure Diagram

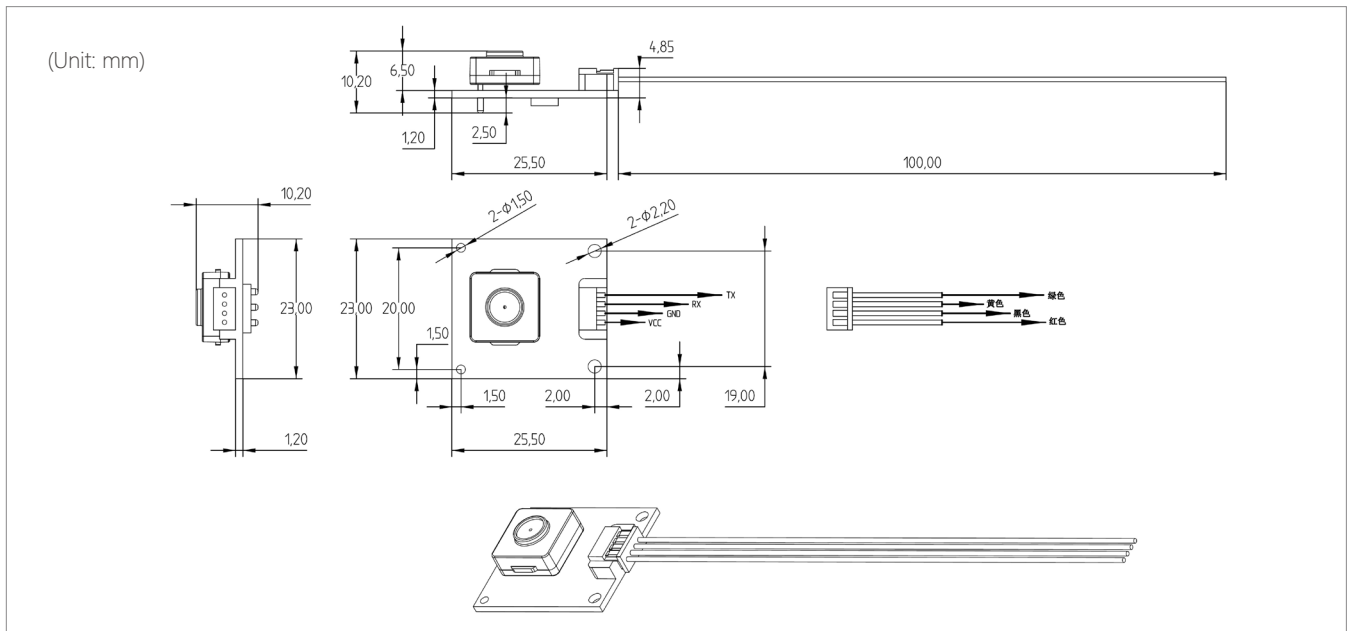

## Order Information

Product	Part Number	Range	Resolution
CO Gas Module	04-TB600B-CO-10-01	0-10ppm	0.01ppm
4Pin Cable	02-MOD-CABLE-4PIN-01		

## Specification

Principle	Solid Polymer Electrochemical Sensing Technology
Order number	04-TB600B-CO-10-01
Detection of gas	Carbon Monoxide Gas
Detection Range	0 - 10ppm; Display resolution: 0.01ppm
Lowest Detection Limit	0.1ppm;
Full-scale accuracy error	0ppm - 5ppm error is $\pm 2-5\%$ (5ppm is the calculation unit);
	5ppm - 10ppm error $\pm 5\%$ (10ppm is the calculation unit);
Settling time	The first power-on storage in clean air <120 seconds
	The first power-up storage in non-clean air <240 seconds (except in the presence of high concentrations of polluted gas)
Response time	<3 seconds ( T50: <40 seconds; T90: <80 seconds; T100: <180 seconds;)
Return zero time	<120 seconds (Pass 99.999% high purity nitrogen)
Calibration substance	10ppm measurement range: 5ppm carbon monoxide gas calibration;
	Note: The smaller the range, the higher the detection accuracy, the user is not recommended to use over-range.
Sensor life expectancy	Relatively clean air, temperature 0-25 ° C, humidity 30-70% for more than 3 years (often exposed to corrosive gas, high temperature environment and <20% low humidity environment, sensor life will be reduced)
Relative temperature error	$\pm 0.2^{\circ}\text{C}$
Relative humidity error	$\pm 2\%$
Output	3.3V UART digital signal (see below for communication protocol)
	Interface definition: VCC- red, GND- black, RX- yellow, TX- green;
	Baud rate: 9600 Data bits: 8 bits Stop bits: 1 bit;
Get data command	Communication has active upload and Q & A mode. The default mode is Q & A mode after power-on. You can use instructions to switch between the two modes.
	Or Q & A mode is restored by power off or switch power mode
	See next page for details
Working Voltage	3.3-5.5V DC
Working Current	< 5mA
Power Consumption	25mW @ 5V DC
Repeatability	Full range 10ppm $\pm 1\%$ is the normal range
Working temperature	0-40°C , storage temperature -20-55°C (with temperature compensation, suitable for indoor use, if applied in outdoor or industrial environment, it is recommended that customers choose TB200B series industrial grade module -40-55°C )
Optimal working temperature	20 - 35°C
Working humidity	15% - 95% RH. (Non-condensing)
Optimum working humidity	40 - 70% RH.
Working pressure	Atm $\pm 10\%$
Board size	23 x 25.5X10.2mm (with sensor)
Board size	23 x 25.5X4.85mm (without sensor)
Weight	3.1g
Signal cable	The standard length is shown in the figure, and can be customized if there are special requirements.

## User Guide

Thank you for choosing EC Sense Gas module. Before using it, please read this document in detail in order to use our products correctly and effectively.

### Storage

The solid polymer sensor can be stored for more than 1 year at a humidity of 20-95% and a temperature of -5-25°C . Ensure that the storage environment is free from high concentrations of contaminated. Gases as far as possible. Sensors with a storage time of more than half a year, and the first power-on polarization time of more than 12 hours can fully activate the electrolyte and restore the best detection state.

1. The best storage environment of TB600B CO sensor module is: temperature -5°C -25°C , Relative humidity 25% - 95% (non-condensing);
2. The storage environment should keep the air clean, no pollution gas, no high concentration organic gas, no dust, no smoke;
3. Avoid storage with alcohol (ethanol), perfume, sodium silicate, and polyurethane liquids and solids.

### Packaging and transportation

1. Avoid prolonged direct sunlight during transportation, prevent rainwater penetration;
2. Transport packaging should be protected by Shock-proof bubble film or non-odor environmentally friendly sponge;
3. During long-term long-distance transportation, the temperature in the sensor package should be kept within 40°C as much as possible, and the maximum temperature should not exceed 55°C (do not store or use at this temperature for a long time);
4. During the transportation of the finished product, seal the air inlet of the sensor as much as possible to prevent the contaminated gas from entering the sensor, which will cause the value too high or the stabilization time too long when user use the product for the first time.

### Steps for usage

#### 1. Wiring

- Perform the corresponding wiring according to the identification of the output signal port of the structure diagram. Please refer to the 4Pin signal line label in the "Structure Diagram" above. For the power supply, see the voltage and current ranges marked in the indicators.  
Note: incorrect wiring will cause the module to malfunction or damage the module.

#### 2. Stable time

- The CO module needs a short stabilization time after power-on. The module is designed with plug-and-play function, and usually the stabilization time is within 2 minutes. However, if the concentration of the contaminated gas is high during storage, transportation or on-site environment, the stabilization time will increase. If the on-site ambient air is highly fluid, there will be fluctuations in the data. Please pay close attention to the on-site environment status. When the environmental condition is stable and there is no strong convection and air exchange, such as opening windows, opening doors, fans, air conditioners, fresh air systems, etc., As soon as the output signal is constant, and detection can begin .
- (Note: Since it is a ppb-level high-precision module, the first power-on stabilization time varies under different storage and measurement environments.)
- When the module is stable, CO gas is usually present in normal air. Please refer to the CO data released by the nearest local environmental monitoring station for reference.

#### 3. Diffusion use

- The module is used with a diffuse detection ambient gas, that is, the airflow naturally diffuses into the sensor. When the environment has a flow rate, it is necessary to ensure that the flow rate is within 500ml and that the flow rate is stable. The change of flow will cause the signal to fluctuate. When the flow is large, it will bring the change of pressure, which will cause the sensor signal value to change. The flow velocity will generate pressure, and the change in pressure will cause the output signal to change. The signal will increase when the pressure increase, And the sensor signal will change suddenly when the pressure change suddenly. Avoid negative pressure environment, which will cause physical irreparable damage to the sensor.

#### 4. Temperature and humidity effects

- The module has been corrected for temperature compensation through an intelligent algorithm, which is suitable for the detection environment of 0-40°C . The sensor can work in the environment of -40°C -55 °C . There will be detection values in the temperature range outside the temperature compensation. The deviation is large. If you have special requirements, please contact the original factory for customization.



## User Guide

- The sensor is not affected by normal humidity changes, but rapid humidity changes will cause instantaneous peak changes, mainly due to condensation on the sensor surface caused by humidity changes, which will prevent outside air from entering the sensor, but the sensor will go stable in short time. The frequent and rapid changes in temperature or humidity will affect the chemical materials and cause the sensor life to be unexpectedly reduced. Due to the principle and characteristics of electrochemical sensors, changes in the environment have different levels of influence on the chemical electrolyte inside the sensor. The EC Sense CO sensor module analyzes the changes of the sensor current data in detail through different environmental temperature and humidity impact tests, and combines the temperature and humidity sensor data to perform algorithmic compensation. During the use of the sensor, pay attention to the sudden changes in temperature and humidity which will cause the sensor data to fluctuate abnormally. The CO sensor has good adaptability to the environment. Generally, it can fully adapt to the new environment and stabilize in 5-10 minutes.
- The sensor module must not be used and stored for a long time in a high-temperature and low-humidity environment with a humidity below 10% and a temperature above 55 ° C. Failure to do so may result in reduced sensor life, or failure, or invalid test data.

### Precautions

1. The main function of the gas sensor is to detect the gas composition and content. Please do not let any part of the sensor contact the liquid;
2. Different gas sensors have different measurement concentration ranges (ranges). Do not measure high-concentration gases for a long time during use;
3. The white or yellow sheet on the sensor is a waterproof and breathable film, please be careful not to scratch or pull it off;
4. Do not block or contaminate the surface of the sensor. Sometimes the blockage of the hole is the cause of reduced sensitivity and slow response time;
5. Please do not exchange the sensors of different gas detection modules. Doing so will cause measurement errors, because all the parameters of each sensor and each circuit board are matched and calibrated, and there will be deviations after the exchange;
6. Once the ES1 sensor is unplugged and re-inserted into the circuit board, please check that the three electrodes of the sensor correspond to the socket on the circuit board correctly to avoid irreversible damage to the sensor after reverse insertion;
7. Avoid excessive impact or vibration, and the case is damaged, please ensure that the structure is used without damage. If the case is damaged, please ensure that the structure is used without damage. If the case is broken and the internal structure is exposed, the output will no longer be reliable;
8. Pins must not be broken or bent. Doing so may damage the internal structure of the sensor;
9. It is slow to return to the initial state after long-term use in a high-concentration gas environment. The recovery speed is proportional to the overrange multiple;
10. 10ppm low range sensor should avoid high concentration and strong viscous gas for a long time contact with the sensor;
11. Please do not disassemble the sensor at will, it will damage the sensor;
12. Measurement range and accuracy. Select a gas sensor that matches the range and accuracy according to the actual application requirements and the gas concentration range. Otherwise, the gas may not be distinguished, accurate data may not be judged, and the sensor may be damaged;
13. When conducting on-site detection of CO gas, avoid the interference of other high-concentration gases on the site with CO, which will cause the error rate of the test results to increase.
14. Due to the principle and characteristics of the electrochemical sensor, in order to ensure the long life and the best working state of the sensor, the sensor should be kept in a continuous power state as much as possible;
15. When the CO module encounters high-concentration gases during use, such as CO gas, ethanol gas, and volatile organic gas. After the impact, the recovery time is slower. Placement in a clean air environment can shorten the recovery time.

### Sensor quality inspection

1. Each sensor produced by EC Sense has a factory inspection test report, and a comprehensive performance test of the main indicators of the sensor. In the sensor manufacturing process, we will perform four index tests in different process links to screen out nonconforming products. Before the production and delivery of the material warehouse, each sensor is tested before entering the warehouse. The sensors are installed in the gas distribution test system, and full-scale standard gas is passed in for a continuous 3-5 minutes. After the test is completed, the system will automatically generate a standard sensor test report (including: serial number, sensitivity, response time T50 T90, return zero time, zero current, maximum current value) strictly in accordance with the system preset Parameter of standard qualified product. The sensors are rejected, which exceed the standards and treated as nonconforming products.

## User Guide

2. All modules are calibrated with standard gas to ensure the consistency and accuracy of the sensor.

### Disclaimer

EC Sense performance data stated above is based on data obtained under test conditions of 26 °C , 55% RH., Flow rate 3000scm, air space: 0.03m<sup>3</sup>, standard atmospheric pressure environment, using EC Sense gas distribution system and AQS test software . In the interest of continuous product improvement, EC Sense reserves the right to change design features and specifications without notice. We are not responsible for any loss, injury or damage caused by this. EC Sense assumes no responsibility for any indirect loss, injury, or damage resulting from the use of this document, the information contained therein, or any omissions or errors herein. This document does not constitute an offer to sell, and the data it contains is for informational purposes only and cannot be considered a guarantee. Any use of the given data must be evaluated and determined by the user to comply with federal, state and local laws and regulations. All specifications outlined are subject to change without notice.

### Warning

EC Sense sensors are designed for use in a variety of environmental conditions, during storage, assembly, and operation, due to the principles and characteristics of solid polymer electrochemical sensors, to ensure normal use, users must strictly follow this article when using this module , And general-purpose PCB circuit board application methods, violation of the application will not be covered by the warranty. Although our products are highly reliable, we recommend that you check the module's response to the target gas before to ensure field use. At the end of the product's useful life, please do not discard any electronics in domestic waste, please follow the local government's electronic waste recycling regulations for disposal.

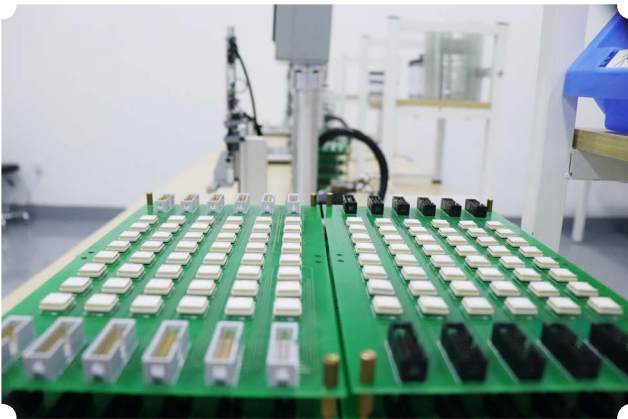

Sensor Production Test

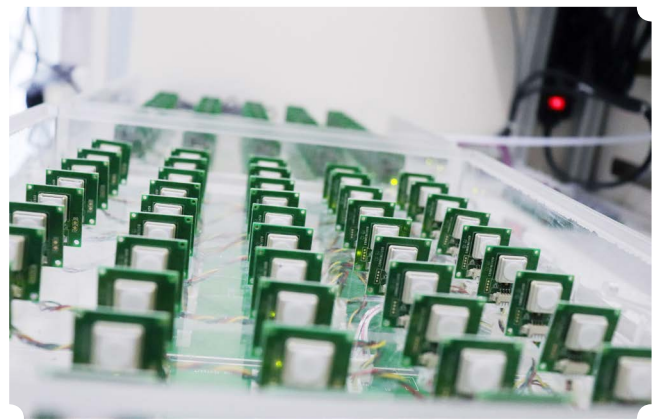

Test module, test calibration

## Communication Protocol

### General Settings

The sensor module uses serial communication. The communication configuration parameters are as follows:

Baud rate	9600
Data bits	8 bits
Stop bits	1 bit
Parity bit	None

Note: The communication has active upload and question-and-answer mode. The default mode is Q & A mode after power-on. You can use commands to switch between the two modes. After power-off or switch power consumption mode, the Q&A mode is restored.

### Transmission mode switching instruction

**Command 1** Switches to active upload. The command line format is as follows:

0	1	2	3	4	5	6	7	8
Start bit	Retain	Switch command	Active upload	Retain	Retain	Retain	Retain	Checksum
0xFF	0x01	0x78	0x40	0x00	0x00	0x00	0x00	0x47

Note: This format is fixed

**Command 2** Switch to passive upload. The command line format is as follows:

0	1	2	3	4	5	6	7	8
Start bit	Retain	Switch command	Answer	Retain	Retain	Retain	Retain	Checksum
0xFF	0x01	0x78	0x41	0x00	0x00	0x00	0x00	0x46

Note: This format is fixed

### Commands in query mode

**Command 3** Get the sensor type, maximum range, unit, and decimal places: 0xD1

Return value:

0	1	2	3	4	5	6	7	8
Sensor type	Maximum range high	Maximum range low	Unit	Retain	Retain	Retain	Number of decimal places(bit[4]~bit[7]   Data sign (bit[0]~bit[3]))	Parity bit
0x19	0x00	0xC8	0x02	0x00	0x00	0x00	0x01	0x35

Note:

Max range = (Max range high << 8) | Max range low

Unit: 0x02 (ppm and mg / m<sup>3</sup>) 0x04 (ppb and ug / m<sup>3</sup>)

Signs: 0 (positive) 1 (negative)

Decimal places: how many decimal places to read the concentration value, the maximum number of decimal places is 3

## Communication Protocol

**Command 4** Get the sensor type, maximum range, unit, and decimal places: 0xD7

0	1	2	3	4	5	6	7	8
Command header 1	Command header 2	Sensor type	Maximum range high	Maximum range low	Unit	Number of decimal (bit[4]~bit[7]) Data sign (bit[0]~bit[3])	Retain	Parity bit
0xFF	0xD7	0x19	0x00	0xC8	0x02	0x01	0x00	0x45

**Description:**

Checksum: Add 1 ~ 7 to generate an 8-bit data, invert each bit, add 1 at the end

Decimal places bit [4] ~ bit [7]:

$(\text{bit}[7] \ll 3) | (\text{bit}[6] \ll 2) | (\text{bit}[5] \ll 1) | \text{bit}[4]$  = number of decimal places

Data sign (bit[0]~bit[3]):

$(\text{bit}[3] \ll 3) | (\text{bit}[2] \ll 2) | (\text{bit}[1] \ll 1) | \text{bit}[0] = 0$  Negative inhibition

$(\text{bit}[3] \ll 3) | (\text{bit}[2] \ll 2) | (\text{bit}[1] \ll 1) | \text{bit}[0] = 1$  Positive inhibition

Unit :

0x02: unit is mg/m<sup>3</sup> and ppm

0x04: unit is um/m<sup>3</sup> and ppb

0x08: unit is 10g/m<sup>3</sup> and %

**Command 5** The format for actively reading the gas concentration value is as follows:

0	1	2	3	4	5	6	7	8
Start bit	Retain	Command	Retain	Retain	Retain	Retain	Retain	Checksum
0xFF	0x01	0x86	0x00	0x00	0x00	0x00	0x00	0x79

Return value:

0	1	2	3	4	5	6	7	8
Start bit	Command	High gas concentration (ug/m <sup>3</sup> )	Low gas concentration (ug/m <sup>3</sup> )	Full range high	Full range low	High gas concentration (ppb)	Low gas concentration (ppb)	Checksum
0xFF	0x86	0x00	0x2A	0x00	0x00	0x00	0x20	0x30

**Description:**

Checksum: Add 1 ~ 7 digits of data to generate an 8-bit data, invert each bit, add 1 at the end.

Gas concentration value = gas concentration high bit \* 256 + gas concentration bit;

(The high and low concentrations need to be converted from hexadecimal to decimal and then brought into this formula to calculate)

## Communication Protocol

**Command 6** Combined reading command of gas concentration value and temperature and humidity

0	1	2	3	4	5	6	7	8
Start bit	Retain	Command	Retain	Retain	Retain	Retain	Retain	Checksum
0xFF	0x01	0x87	0x00	0x00	0x00	0x00	0x00	0x78

Return value:

0	1	2	3	4	5	6	7	8	9	10	11	12
Start bit	Command	High gas concentration (ug/m <sup>3</sup> )	Low gas concentration (ug/m <sup>3</sup> )	Full range high	Full range low	High gas concentration (ppb)	Low gas concentration (ppb)	Temperature high	Temperature low	Humidity high	Humidity low	Parity bit
0xFF	0x87	0x00	0x2A	0x03	0xE8	0x00	0x20	0x09	0xC4	0x13	0x88	0xDC

**Description:**

Checksum: 1 ~ 11 bits of data are added to generate an 8-bit data, each bit is inverted, and 1 is added at the end.

Gas concentration value = gas concentration high bit \* 256 + gas concentration bit;

(The high and low concentrations need to be converted from hexadecimal to decimal and then brought into this formula to calculate)

Temperature is signed data with two decimal places, the unit is (°C -Celsius). Pseudo code calculation formula:

$$T = (\text{float})((\text{int})((0x0A \ll 8) | 0x09)) / 100$$

Humidity is data without sign and two decimal places, the unit is (rh%). Pseudo code calculation formula:

$$Rh = (\text{float})((\text{uint})((0x0A \ll 8) | 0x09)) / 100$$

**Command 7** Get the current temperature and humidity:

Return value:

0	1	2	3
Temperature high 8 bit	Temperature low 8 bit	Humidity high 8 bit	Humidity low 8 bit
0x0A	0x09	0x11	0xF4

**Description:**

Temperature is signed data with two decimal places, the unit is (°C -Celsius). Pseudo code calculation formula:

$$T = (\text{float})((\text{int})((0x0A \ll 8) | 0x09)) / 100$$

Humidity is data without sign and two decimal places, the unit is (rh%). Pseudo code calculation formula:

$$Rh = (\text{float})((\text{uint})((0x0A \ll 8) | 0x09)) / 100$$

## Communication Protocol

**Command 8** Get the current temperature and humidity with calibration

Return value:

0	1	2	3	4
Temperature high 8 bit	Temperature low 8 bit	Humidity high 8 bit	Humidity low 8 bit	Checksum
0x0A	0x09	0x11	0xF4	0xE8

**Description:**

Checksum: 0 ~ 3 bits of data are added to generate an 8-bit data. Each bit is inverted, plus 1 at the end.

Temperature is data with a sign and two decimal places. The unit is (°C -Celsius). Pseudo-code calculation formula:

$$T = (\text{float})((\text{int})((0x0A \ll 8) | 0x09)) / 100$$

Humidity is data without sign and two decimal places, the unit is (rh%). pseudo code calculation formula:

$$Rh = (\text{float})((\text{uint})((0x0A \ll 8) | 0x09)) / 100$$

**Command 9** Get the current version number

Return value:

0	1	2	3	4	5
0x19	0x05	0x27	0x00	0x10	0x01

**Data active upload mode**

The upload data format is as follows:

0	1	2	3	4	5	6	7	8
Start bit	Command	High gas concentration (ug/m <sup>3</sup> )	Low gas concentration (ug/m <sup>3</sup> )	Full range high	Full range low	High gas concentration (ppb)	Low gas concentration (ppb)	Checksum
0xFF	0x86	0x00	0x2A	0x00	0x00	0x00	0x20	0x30

**Note:**

Checksum: 1 ~ 11 bits of data are added to generate an 8-bit data, each bit is inverted, and 1 is added at the end.

Gas concentration value = gas concentration high bit \* 256 + gas concentration bit;

(The high and low concentrations need to be converted from hexadecimal to decimal and then brought into this formula to calculate)

## Communication Protocol

### Low power switching

#### Enter sleep mode

0	1	2	3	4	5
0xAF	0x53	0x6C	0x65	0x65	0x70

Return value:

0	1
0x4F	0x4B

#### Exit sleep mode

0	1	2	3	4
0xAE	0x45	0x78	0x69	0x74

Return value:

0	1
0x4F	0x4B

Note: After exiting sleep mode, it takes 5 seconds to recover, no data within 5 seconds

### 0x19,0x07,0x06,0x13,0x47,0x25 Low power instructions that can be used later

#### Enter sleep mode

0	1	2	3	4	5	6
0xA1	0x53	0x6C	0x65	0x65	0x70	0x32

Return value:

0	1	2	3	4	5	6	7	8
0xFF	0xA1	0x00	0x00	0x00	0x00	0x00	0x00	5F

#### Exit sleep mode

0	1	2	3	4	5
0xA2	0x45	0x78	0x69	0x74	0x32

Return value:

0	1	2	3	4	5	6	7	8
0xFF	0xA2	0x00	0x00	0x00	0x00	0x00	0x00	5E

## Communication Protocol

### Turn off the running lights

0	1	2	3	4	5	6	7	8
Start bit	Retain	Command	Retain	Retain	Retain	Retain	Retain	Checksum
0xFF	0x01	0x88	0x00	0x00	0x00	0x00	0x00	0x77

Return:

0	1
0x4F	0x4B

### Turn on the running lights

0	1	2	3	4	5	6	7	8
Start bit	Retain	Command	Retain	Retain	Retain	Retain	Retain	Checksum
0xFF	0x01	0x89	0x00	0x00	0x00	0x00	0x00	0x76

Return:

0	1
0x4F	0x4B

### Query the running light status

0	1	2	3	4	5	6	7	8
Start bit	Retain	Command	Retain	Retain	Retain	Retain	Retain	Checksum
0xFF	0x01	0x8A	0x00	0x00	0x00	0x00	0x00	0x75

Return:

0	1	2	3	4	5	6	7	8
Start bit	Command	State value	Retain	Retain	Retain	Retain	Retain	Checksum
0xFF	0x8A	0x01	0x00	0x00	0x00	0x00	0x00	0x75

**Note:** Status value 1 (light on), 0 (light off)



**Business Centre**  
**Europe and the rest of the world**

EC Sense GmbH  
Wolfratshauser Str.53,  
82067 Ebenhausen, Germany  
Tel: +49(0)8178 909 5130 Fax: +49(0) 8178 909 5131  
Email: [info@ecsense.com](mailto:info@ecsense.com) [www.ecsense.com](http://www.ecsense.com)

**Business Centre**  
**Asia**

Ning AQSystems Technology Co., Ltd.  
F4-17 Buliding, Zhong Wu Technology Park No.228,  
Jin Gu Bei Road, Yingzhou District NinBo,  
Zhejiang Province, P.R. China Post Code: 315100  
Tel: +86(0)574 88097236, 88096372  
Email: [info@aqsystems.cn](mailto:info@aqsystems.cn) [www.ecsense.cn](http://www.ecsense.cn)